



Glass Oven G-300

The Multipurpose Solution For Small Samples



Glass Oven G-300

Simplify your workflow with one instrument

Introducing the Glass Oven G-300, BUCHI's all-in-one instrument for small samples. With interchangeable accessories, the Glass Oven G-300 can perform distillation, drying, sublimation, and freeze-drying, eliminating the need for multiple large instruments. Its compact size even allows placement in a glovebox, ensuring the safe handling of air-sensitive samples.



All-In-One Solution

The Glass Oven G-300 comes in two configurations, each with a range of interchangeable accessories allowing for various applications. The Glass Oven G-300 Drying can be used for drying, sublimation, and freeze-drying, while the Glass Oven G-300 Kugelrohr can be used for distillation and drying under rotation.

Gentle Sample Processing

The Glass Oven G-300 features a semiconductor coating that ensures uniform heat distribution and accelerates heating and cooling. This gentle heating minimizes thermal damage to your samples, while the transparent chamber allows for real-time sample monitoring.



Effortless Savings

Maximize your efficiency with the intuitive Glass Oven G-300. Processing small samples on large instruments is inefficient and wastes energy. The compact Glass Oven G-300 was designed for optimal performance and ease of use, making it suitable for all skill levels and perfect for crowded labs.



Angle adjustment button

To adjust the angle of the heating tube.

SET button

To set heating temperature.

Heating tube

With semiconductor coating for gentle heating and fast heating and cooling times.

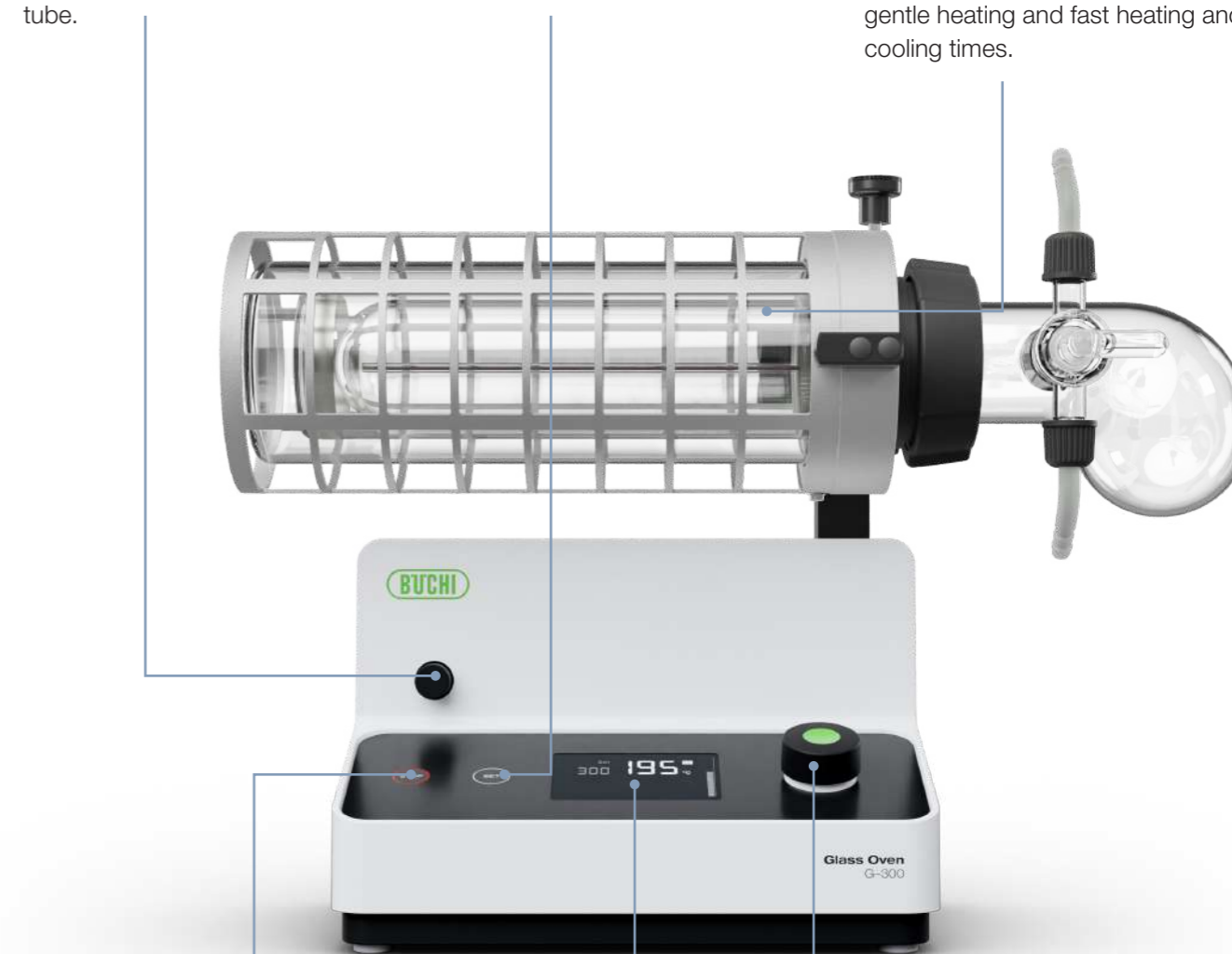

STOP button

To stop the process and the connected vacuum pump.

Interface

Showing heating temperature and rotation speed.

Navigation control

To adjust heating temperature and rotation speed.

One Instrument, Many Methods

Sample preparation streamlined

Expand your glass oven's capabilities with interchangeable accessories for various processes. The Glass Oven G-300 is available in two configurations, and all accessories can be acquired separately if needed.

Glass Oven G-300 Drying



Drying

Ensure gentle and efficient drying of small samples at temperatures up to 300 °C. For heat-sensitive samples, drying can be performed under vacuum to preserve the integrity and quality of delicate materials.

Sublimation

Sublimation is the direct transition of a substance from a solid to a gas, bypassing the liquid phase. It yields exceptionally pure products without requiring additional solvents. To perform this method, add the sublimation accessory.

Freeze Drying

Freeze-drying is ideal for preserving the integrity of samples. The process involves freezing a solution and reducing the pressure to sublimate the ice. To perform this method, add the freeze-drying accessory.

Glass Oven G-300 Kugelrohr



Distillation

Perform simple and fractional distillations of small liquid volumes. It uses a bulb-to-bulb method for condensation outside the oven. Extend the number of bulbs by up to four to match the mixture's components. For low-boiling substances, a cooling tray can be filled with a cooling agent.

Drying Under Rotation

Some samples form a hard surface layer, drastically increasing the drying time. To avoid this, use the rotation drying flask to keep the sample in constant rotation.



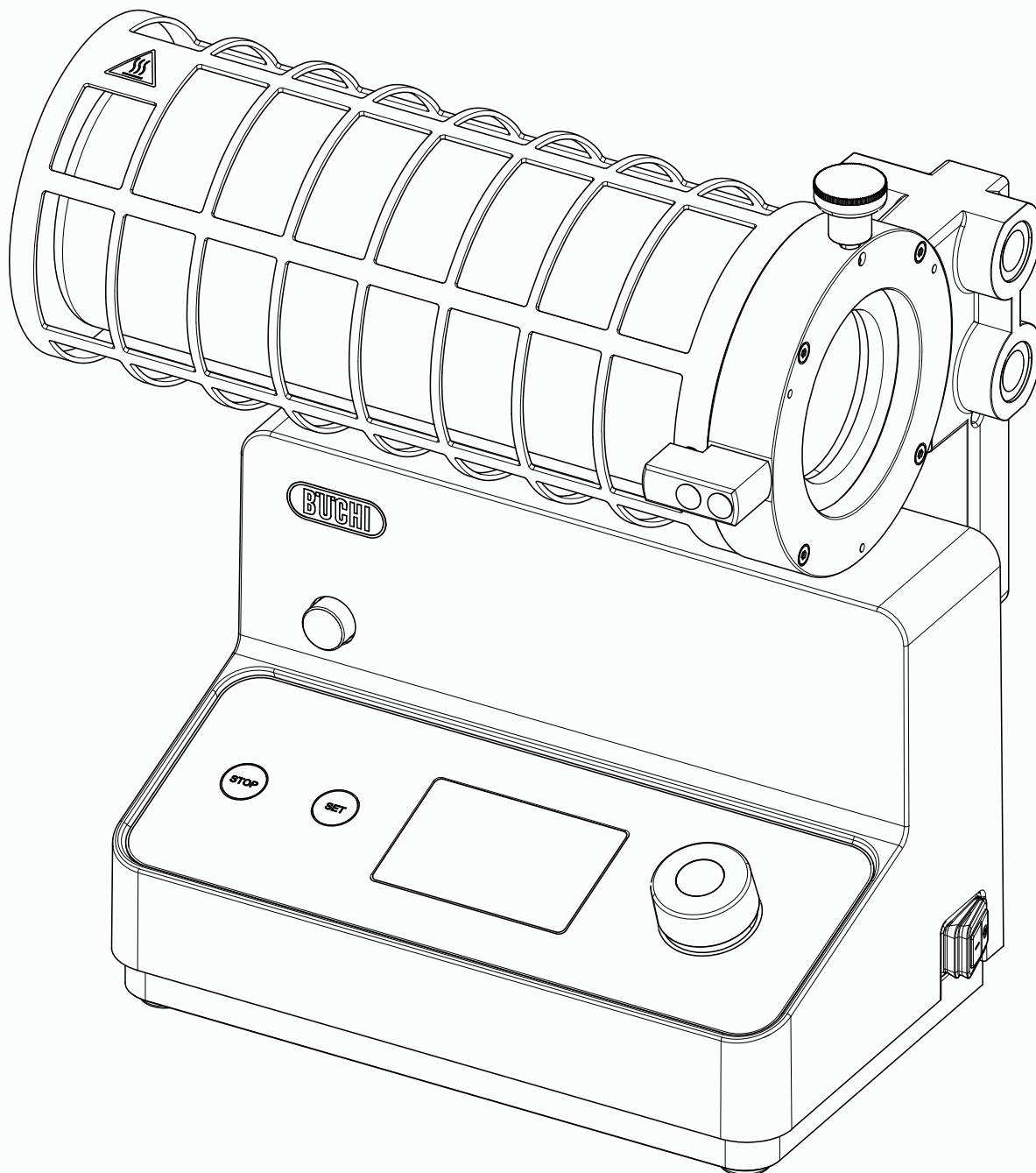

Technical data sheet

Glass Oven G-300

The instrument is known for its versatility in lab applications like drying, sublimation, freeze-drying, and distillation, making it essential universal equipment with customizable options. It features an innovative gentle heating technique with a semi-conductor coating for even heat distribution, speeding up the process and allowing real-time sample monitoring to prevent thermal damage.



Scope of delivery

All configurations are supplied ready to use.



NOTE

The scope of delivery depends on the configuration of the purchase order.

Accessories are delivered as per the purchase order, order confirmation, and delivery note.

Components	Glass Oven G-300	Glass Oven G-300
	Drying	Kugelrohr
Glass Oven G-300	1	1
Drying tube	1	-
Glass ball incl. stop cock	1	-
Aluminum flange ring	1	-
Flange nut incl. spring	1	-
Drive unit	-	1
Cooling device	-	1
Suction angle	-	1
Rotation drying flask 30 mL	-	1
Ball tube with 3 balls of 20 mL	-	1
Power cable	1	1

Order code

Choose the configuration according to your needs:



Glass Oven G-300 (100–230 V)

- 0 Without
only the main unit for reusing the existing accessories
- 1 Drying
incl. main unit and Drying accessory
- 2 Kugelrohr
incl. main unit and Kugelrohr accessory

Technical data

Glass Oven G-300

Specification	Glass Oven G-300 Drying	Glass Oven G-300 Kugelrohr
Dimensions (W × D × H)	400 mm × 180 mm × 295 mm	750 mm × 190 mm × 805 mm
Weight	6.0 kg	7.6 kg
Volume	up to 250 mL (sample vol.)	5–40 mL (flask size)
Adjustable angle	0–90°	0–90°
Rotation speed range	–	0–100 rpm
Connection voltage	100–240 VAC ±10%	100–240 VAC ±10%
Frequency	50 / 60 Hz	50 / 60 Hz
Power consumption	600 W	600 W
Fuse	3.15 AT	3.15 AT
Overvoltage category	II	II
IP Code	IP20	IP20
Pollution degree	2	2
Minimum clearance on all sides	300 mm	300 mm
Display type	3" Dark segment display	3" Dark segment display
Temperature range	up to 300 °C	up to 300 °C
Temperature precision	± 5 °C	± 5 °C
Temperature adjustment accuracy	± 1 °C	± 1 °C
Warm-up time (from 20 to 300 °C)	approx. 10 min	approx. 10 min
Certificate	CB, CE, UL / CSA	CB, CE, UL / CSA

Ambient conditions

For indoor use only.

Specification	Value
Max. altitude above sea level	2,000 m
Ambient and storage temperature	5–40 °C
Max. relative humidity	80% for temperatures up to 31 °C decreasing linearly to 50% relative humidity at 40 °C

Spare parts and accessories

Use only genuine BUCHI consumables and spare parts in order to ensure correct, safe and reliable operation of the system.





NOTE

Any modifications of spare parts or assemblies are only allowed with the prior written permission of BUCHI.

Accessories

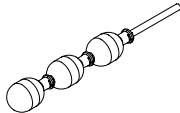
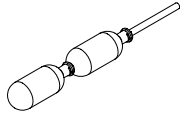
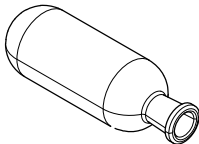
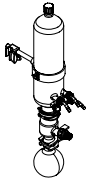
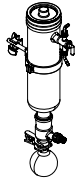
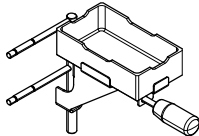
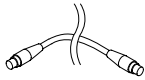
	Order no.	Image
<p>Kugelrohr accessory</p> <p>Complete ball tube drive for converting to a ball tube distillation oven (Kugelrohr). Incl. cooling device, drive unit, and suction angle.</p>	11082306	
<p>Drying accessory</p> <p>For converting to the drying model. For sample volumes up to 250 mL. Incl. drying tube, glass ball, stopcock, flange ring, spring, and O-ring</p>	037010	
<p>Freeze drying accessory. Incl. glass tube, screw cap, O-ring</p> <p>For freeze drying applications. Meant to be used with the drying accessory and either a condenser or cold trap.</p>	046710	
<p>Sublimation accessory. Incl. sublimation finger</p> <p>Meant to be used with the drying accessory.</p>	036766	
<p>Sublimation accessory. Incl. drying tube, glass tube, sublimation finger, stopcock, flange ring, O-ring</p> <p>For conversion to the sublimation configuration</p>	037133	
<p>Rotation drying flask. Glass, 30 mL, SJ14/23</p> <p>Content: Drying flask, vapor duct, clip</p>	037143	
<p>Ball tube. Glass, 10 mL (4 pcs), SJ14/23</p> <p>Content: Ball tubes, vapor duct, clips</p>	037118	

	Order no.	Image
Ball tube. Glass, 20 mL (3 pcs), SJ14/23 Content: Ball tubes, vapor duct, clips	037107	
Ball tube. Glass, 40 mL (2 pcs), SJ14/23 Content: Ball tubes, vapor duct, clips	037117	
End bulb spec. D 40mm Content: End ball tube	11061825	
Condenser V. Vertical condenser, 1500 cm ² , Safety Coating For distillations and freeze drying application. Used with recirculating chiller or tap water. Content: 250 mL receiving flask, ball joint clamp, vacuum connection (Safety Coating).	046711	
Condenser C. Cold trap, 500 cm ² , Safety Coating For freeze drying application and for distillations of low-boiling point solvents. Content: 250 mL receiving flask, ball joint clamp, vacuum connection (Safety Coating).	046712	
Cooling unit. Incl. cooling tray For substances with a low boiling point, to condense the vapor in the balls outside of the oven area. Cooling tray can be filled with e.g. ice water or dry ice.	11080855	
Communication cable, Mini-DIN, 0.6 m	11060882	
Cable. Mini-DIN, 1.5 m Connection between glass oven and vacuum pump that does not have a COM connection.	038010	

Wear parts

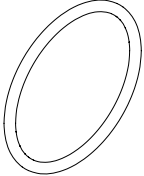
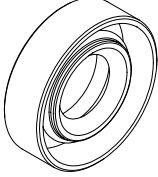
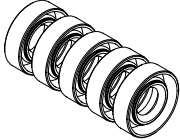
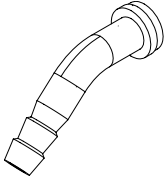
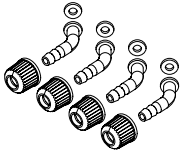
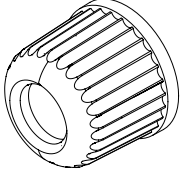
	Order no.	Image
O-ring. NBR, Ø 50.4 mm For the drying accessory and the sublimation glass assembly.	002797	
Vacuum gasket. Shaft seal ring, NBR, Ø 10/24 mm Used in fixation nut to attach stopcock to Kugelrohr drive unit (046765).	002862	
Vacuum gaskets, set. 5 pcs, shaft seal ring, NBR, Ø 10/24 mm	037288	
Hose barb, bent, GL 14, incl. silicone seal	018916	
Hose barbs, set. 4 pcs, bent GL 14, silicone seal Content: Hose barbs, cap nuts, seals	037287	
Cap nut GL14	033577	

Hoses

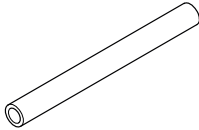

	Order no.	Image
Tubing, silicone, Ø 6/9 mm, transparent, per m Use: Cooling media	004133	



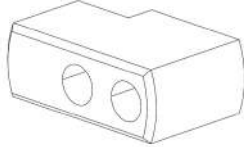
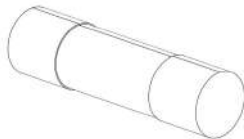
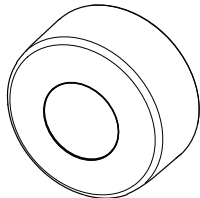
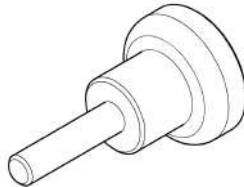

Spare parts

Main unit

	Order no.	Image
Handhold for angle adjustment	046633	
Fuses, set. 10 pcs. T 3.15A H 250V (100–240 V), 20 mm, Ø5 mm	019659	
Navigation control knob	11074581	
Knurled screw M5	046683	

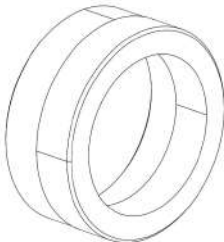
Drying

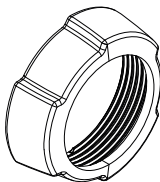
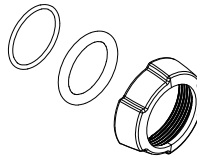
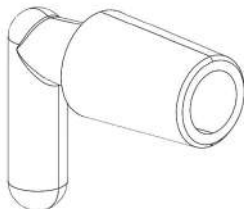

	Order no.	Image
Glass ball Incl. cap nut GL14, Olive bent GL14 Si.	036765	
Drying tube 230 × 50 mm	002965	

	Order no.	Image
Aluminum flange ring 68.5 × 29 mm To attach drying tube to the instrument.	002970	
Insert spring	000590	
Flange nut TR 68 × 3 mm To attach glass ball to drying tube.	036848	
Flange nut set cpl. Incl. flange nut, insert spring, O-ring	037285	
Stop cock STJ18.8/26	037132	
Drying flask 5 mL 270 pcs.	003007	
Holder for flasks	003006	
Holder with glass tubes cpl. Incl. holder, 5 mL flask set. 270 pcs	001981	

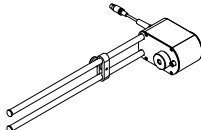
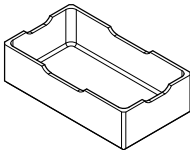
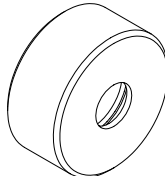
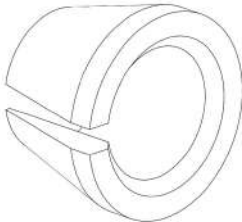

Freeze-drying

	Order no.	Image
O-ring D 30.00 × 4.00 EPDM 70ShA	037179	
Screw cap SVL 30	005223	

Kugelrohr

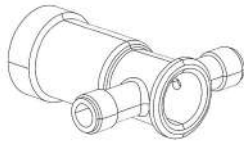
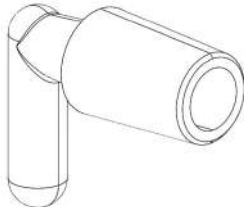
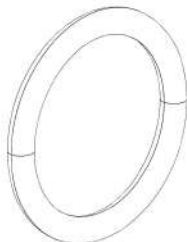
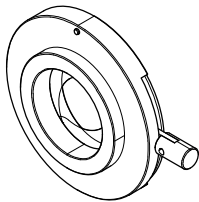
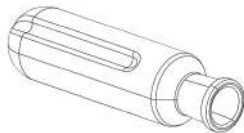
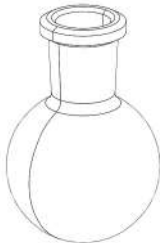
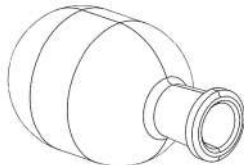
	Order no.	Image
Drive unit cpl. Incl. motor unit, cap nut, clamping cone, guiding tubes, cable	11082309	
Cooling tray For substances with a low boiling point, to condense the vapor in the balls outside of the oven area. Cooling tray can be filled with e.g. ice-water or dry ice.	11081778	
Cap nut. Ø 20/35 mm, black	036824	
Clamping cone	036770	
Suction angle cpl. Incl. connection cock 3-Way GL14, nut, stop cock, gasket NBR, insert spring.	040461	

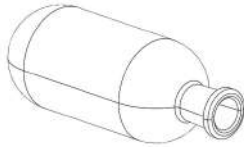
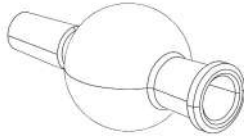
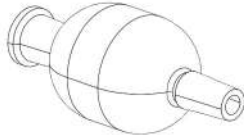
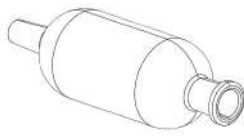
	Order no.	Image
Connection cock 3-Way GL14 Incl. cap nut GL14, Olive bent GL14 Si.	036771	
Stop cock STJ18.8/26	037132	
Insert spring For suction angle cpl. (040461)	002859	
Iris diafragm cpl.	046605	
Rotation drying tube 30 mL	036480	
End bulb 10 mL	037101	
End bulb 20 mL	037104	

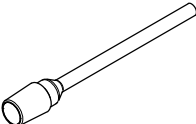
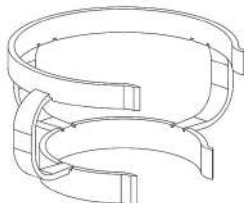
	Order no.	Image
End bulb 40 mL	036478	
Bulb with 2 openings 10 mL	037102	
Bulb with 2 openings 20 mL	037106	
Bulb with 2 openings 40 mL	036479	
Vapor duct 14/23 For ball tubes.	037073	
Vapor duct 24/29 For rotation flask.	037125	
Set Clamp SJ14.5 (5pcs) Incl. clamps SJ14.5 (5 pcs).	040893	

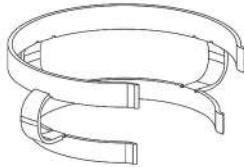
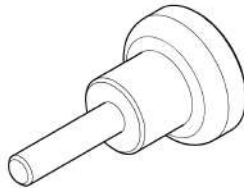
	Order no.	Image
Set Ns-Clamps Incl. clamps SJ14.5 (5 pcs), clamps SJ19 (5 pcs), clamps SJ24 (2 pcs).	037286	
Clamp SJ24	037479	
Knurled screw M5	046683	

Consumables

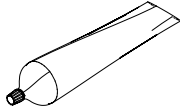
	Order no.	Image
Lab grease. Glisseal 40 (30 g) To grease joints in order to increase tightness of system.	048197	



11594665A en Glass Oven G-300 03.2025
Technical data are subject to change without notice
Quality Systems ISO 9001

We are represented by more than 100 distribution partners worldwide.
Find your local representative at:

www.buchi.com

Quality in your hands



11594665A en Glass Oven G-300 03.2025
Technical data are subject to change without notice
Quality Systems ISO 9001

We are represented by more than 100 distribution partners worldwide.
Find your local representative at:

www.buchi.com

Quality in your hands
